

Model: D3DS-100 X

Data

Type: Semi-hermetic piston compressors

Producer: Copeland

Series: DISCUS

Model: D3DS-100 X

Technical data

Cylinder count:	3
Displacement [m ³ /h]:	49,9
Weight [kg]:	173
Oil charge [dm ³]:	3,4
Max. operating current [A]:	19,5
Locked rotor current [A]:	121
Power supply [V/~/Hz]:	380-420V/3/50Hz

Connections

	<u>milimeters</u>	<u>inches</u>
Suction line:		1 3/8"
Discharge line:		1 1/8"

Model: D3DS-100 X

Capacity

R134a

Cooling capacity [kW]

$t_c \setminus t_e$	-20	-15	-10	-5	0	5	10
30	10.61	13.96	17.95	22.68	28.24	34.73	42.26
35	9.72	12.92	16.72	21.22	26.51	32.70	39.89
40	8.89	11.93	15.54	19.80	24.83	30.71	37.54
45	8.12	11.00	14.41	18.43	23.18	28.75	35.22
50	7.43	10.14	13.34	17.12	21.58	26.83	32.94
55	6.82	9.35	12.34	15.86	20.04	24.95	30.70
60	6.28	8.64	11.40	14.67	18.55	23.13	28.50

Power input [kW]

$t_c \setminus t_e$	-20	-15	-10	-5	0	5	10
30	4.35	4.85	5.29	5.64	5.88	5.98	5.93
35	4.50	5.07	5.60	6.04	6.39	6.62	6.70
40	4.65	5.29	5.90	6.44	6.89	7.23	7.43
45	4.81	5.51	6.19	6.81	7.36	7.81	8.13
50	4.97	5.73	6.47	7.17	7.81	8.36	8.79
55	5.13	5.94	6.74	7.51	8.23	8.88	9.42
60	5.30	6.15	7.00	7.84	8.63	9.37	10.01

Model: D3DS-100 X

Capacity

Current [A]

$t_c \setminus t_e$	-20	-15	-10	-5	0	5	10
30	9.81	10.47	11.06	11.55	11.88	12.03	11.94
35	10.01	10.77	11.48	12.11	12.60	12.93	13.04
40	10.21	11.06	11.89	12.66	13.31	13.81	14.13
45	10.42	11.36	12.30	13.19	14.00	14.68	15.19
50	10.63	11.66	12.70	13.72	14.68	15.53	16.22
55	10.84	11.95	13.09	14.24	15.33	16.35	17.23
60	11.05	12.23	13.47	14.73	15.97	17.15	18.21

Mass flow [kg/s]

$t_c \setminus t_e$	-20	-15	-10	-5	0	5	10
30	250.66	323.57	407.45	503.99	614.90	741.90	886.70
35	241.22	314.14	397.85	494.05	604.46	730.79	874.74
40	232.67	305.41	388.77	484.46	594.18	719.65	862.58
45	225.30	297.69	380.52	475.52	584.38	708.82	850.55
50	219.45	291.30	373.44	467.56	575.38	698.61	838.96
55	215.43	286.57	367.82	460.90	567.50	689.34	828.13
60	213.56	283.81	364.01	455.86	561.06	681.34	818.40

Model: D3DS-100 X



Capacity

C.O.P. [W/W]

$t_c \setminus t_e$	-20	-15	-10	-5	0	5	10
30	2.44	2.88	3.39	4.02	4.80	5.80	7.13
35	2.16	2.55	2.99	3.51	4.15	4.94	5.96
40	1.91	2.25	2.63	3.08	3.61	4.25	5.05
45	1.69	2.00	2.33	2.71	3.15	3.68	4.33
50	1.49	1.77	2.06	2.39	2.76	3.21	3.75
55	1.33	1.57	1.83	2.11	2.43	2.81	3.26
60	1.19	1.41	1.63	1.87	2.15	2.47	2.85

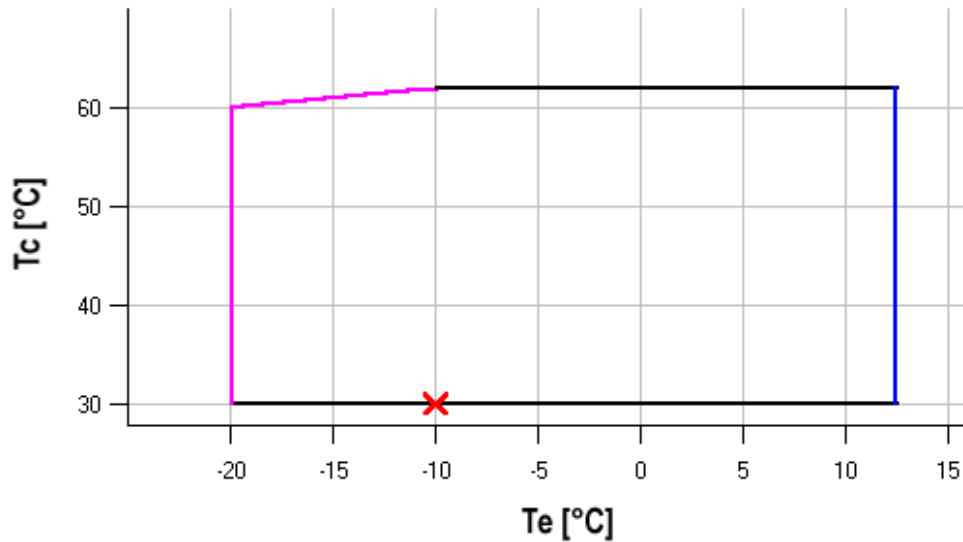
Application range



 Maximum evaporating temperature
 25°C suction gas return

Operating conditions: ISO; subcooling: 0 K, suction superheat: 10 K, return gas temperature: -

t_c - Condensing temperature [°C]

t_e - Evaporating temperature [°C]

Model: D3DS-100 X

Capacity

R404A/R507

Cooling capacity [kW]

$t_c \setminus t_e$	-50	-45	-40	-35	-30	-25	-20
20	5.49	7.48	9.93	12.88	16.39	20.52	25.32
25	4.97	6.84	9.14	11.90	15.19	19.06	23.56
30	4.46	6.22	8.37	10.95	14.01	17.62	21.83
35	3.97	5.62	7.62	10.01	12.86	16.21	20.12
40	-	5.04	6.89	9.10	11.73	14.82	18.44
45	-	4.48	6.19	8.21	10.62	13.46	16.78
50	-	-	5.50	7.34	9.53	12.11	15.14
55	-	-	4.83	6.49	8.46	10.79	13.53

Power input [kW]

$t_c \setminus t_e$	-50	-45	-40	-35	-30	-25	-20
20	3.56	4.19	4.84	5.50	6.13	6.73	7.27
25	3.59	4.27	4.97	5.68	6.39	7.07	7.72
30	3.63	4.33	5.07	5.84	6.62	7.39	8.13
35	3.66	4.39	5.17	5.99	6.83	7.68	8.51
40	-	4.44	5.26	6.13	7.03	7.95	8.87
45	-	4.50	5.35	6.26	7.22	8.21	9.21
50	-	-	5.43	6.39	7.40	8.45	9.53
55	-	-	5.53	6.51	7.57	8.69	9.84

Model: D3DS-100 X

Capacity

Current [A]

$t_c \setminus t_e$	-50	-45	-40	-35	-30	-25	-20
20	9.02	9.73	10.50	11.31	12.14	12.98	13.81
25	9.07	9.84	10.69	11.59	12.54	13.52	14.51
30	9.12	9.94	10.85	11.85	12.91	14.02	15.17
35	9.15	10.01	10.99	12.07	13.25	14.49	15.80
40	-	10.07	11.11	12.28	13.56	14.93	16.38
45	-	10.11	11.21	12.46	13.84	15.33	16.93
50	-	-	11.29	12.62	14.09	15.71	17.45
55	-	-	11.36	12.75	14.32	16.05	17.93

Mass flow [kg/s]

$t_c \setminus t_e$	-50	-45	-40	-35	-30	-25	-20
20	116.02	162.16	217.22	283.07	361.59	454.65	564.13
25	110.91	155.96	209.81	274.32	351.38	442.85	550.61
30	105.51	149.50	202.16	265.36	340.98	430.89	536.96
35	99.94	142.89	194.39	256.30	330.50	418.87	523.27
40	-	136.24	186.59	247.24	320.05	406.90	509.66
45	-	129.64	178.88	238.28	309.73	395.08	496.23
50	-	-	171.36	229.54	299.64	383.53	483.08
55	-	-	164.13	221.12	289.90	372.35	470.33

Model: D3DS-100 X





Capacity

C.O.P. [W/W]

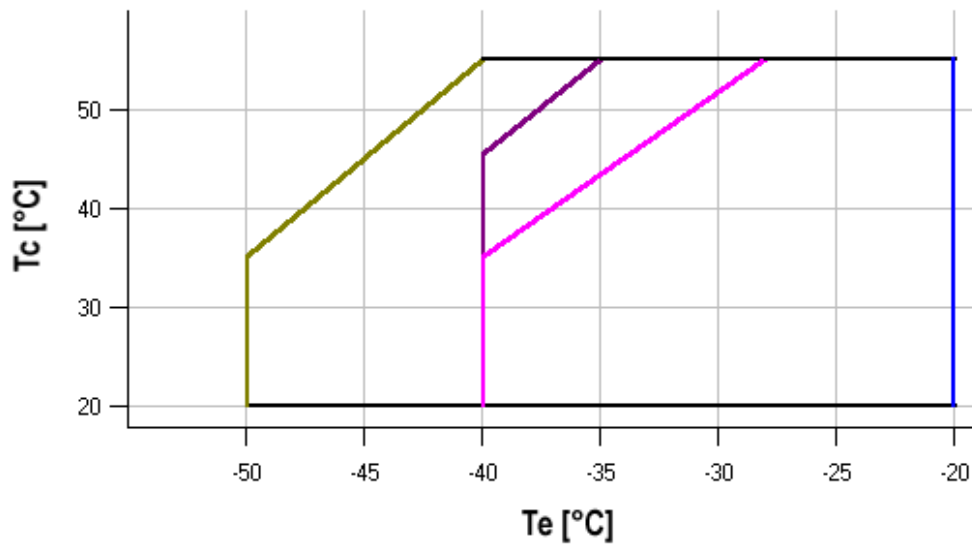
$t_c \setminus t_e$	-50	-45	-40	-35	-30	-25	-20
20	1.54	1.78	2.05	2.34	2.67	3.05	3.48
25	1.38	1.60	1.84	2.10	2.38	2.70	3.05
30	1.23	1.44	1.65	1.87	2.12	2.39	2.69
35	1.09	1.28	1.47	1.67	1.88	2.11	2.36
40	-	1.14	1.31	1.49	1.67	1.86	2.08
45	-	1.00	1.16	1.31	1.47	1.64	1.82
50	-	-	1.01	1.15	1.29	1.43	1.59
55	-	-	0.87	1.00	1.12	1.24	1.38

Application range



-  Maximum evaporating temperature
-  25°C suction gas return
-  0°C suction gas return + additional cooling
-  0°C suction gas return

Operating conditions: ISO; subcooling: 0 K, suction superheat: - K, return gas temperature: 20

t_c - Condensing temperature [°C]

t_e - Evaporating temperature [°C]

Model: D3DS-100 X

Dimensions

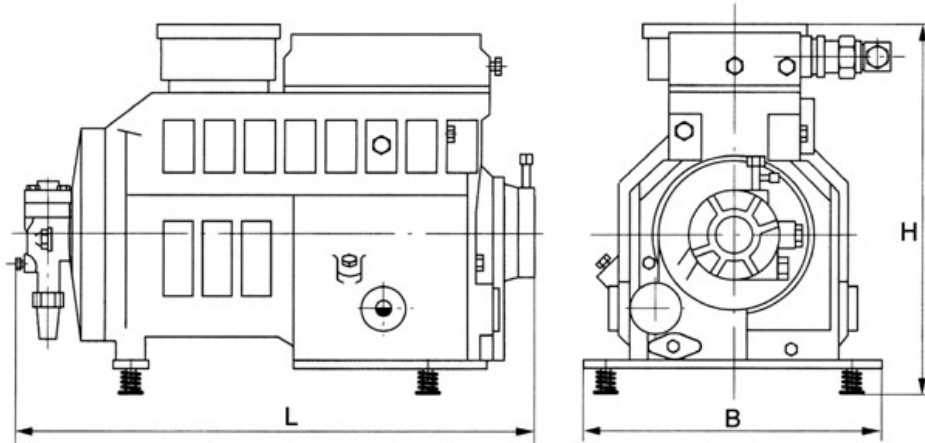

L	680 mm
B	370 mm
H	480 mm

Model: D3DS-100 X

Image

